



Art. Nr.: KBR 44 KBR 44



Dimensions:

Round conductor in mm:	44
Width in mm:	72,2
Height in mm:	120,6
Depth in mm:	98,1

Technical Data:

Therm. nominal continuous current I_{cth} :	$1,2 \times I_N$
Therm. nominal short-time current I_{th} :	$60 \times I_N$, 1 Sek.
Max. operating voltage U_m :	0,72 kV
Isolation test voltage:	3 kV, U_{eff} , 50 Hz, 1 min
Nominal rated frequency:	50 Hz
Isolation class:	E

General Technical Data:

Over-current limiting factor:	See rating plate
Working temperature range:	$-5^\circ\text{C} < T < +50^\circ\text{C}$
Storage temperature range:	$-25^\circ\text{C} < T < +70^\circ\text{C}$
Unbreakable plastic housing made of grey polyamide:	Flame resistant, ultrasonically welded
Custom tariff number	85043129
Applied standards 1	DIN EN 61869-1/2
Applied standards 2	DIN EN 42600-1/2

Technical Drawing:

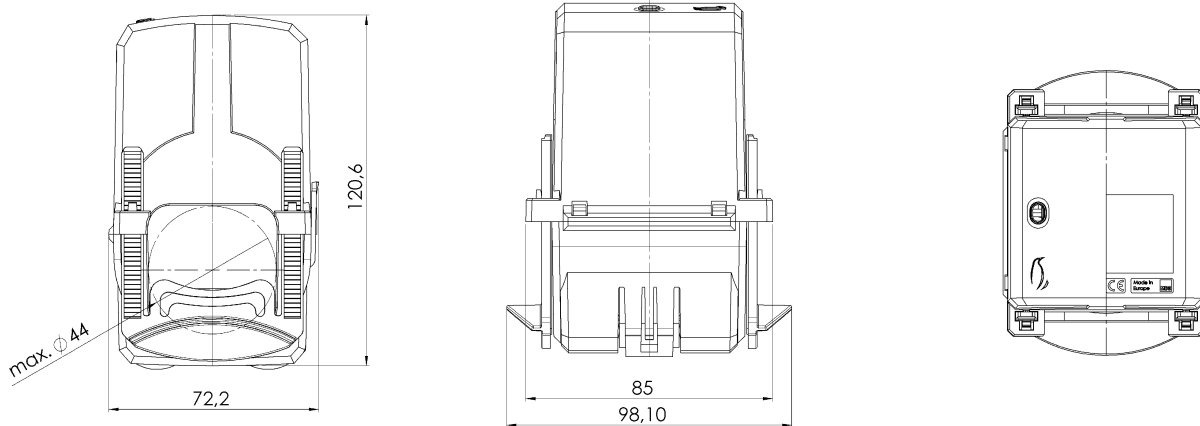

Contact:

MBS AG - Eisbachstrasse 51 - D-74429 Sulzbach-Laufen - www.mbs-ag.com
Tel.: +49 7976 9851-0 - Telefax: +49 7976 9851-90 - verkauf@mbs-ag.com

Date: 12.05.2022